

CI/SfB
(21.9), Xt6
March 2023



GA Fixings Limited

Masonry Support

CE

Part of the Vista Group

GA
A Vista Group Company



As a specifier, engineer or builder you need to be sure the materials you choose are up to the job. You can rely on GA Fixings to deliver the strength, support and reliability your reputation is built on.



Service driven

Quality in masonry support systems starts with quality and expertise in design.

Every day, GA design engineers draw on their years of experience to interpret our customers' requirements and produce the quotes and drawings they need. Quickly, accurately and expertly, every time.

We work closely with buyers, contractors and engineers across

every kind of project to understand the unique challenges they face. So we'll be able to work with you to make sure you get the right system for the right outcome, whatever you're looking to achieve.

Then, we'll deliver it wherever and whenever it's needed through our nationwide supply chain network. A seamless, personalised service with one point of contact from your first enquiry to the final drop off.

Proven systems

Our wide range of standard products and systems is augmented by our full bespoke design service to meet every specific requirement for masonry support.

All manufactured in the UK from the highest grade steel under controlled conditions that have earned us ISO 9001 for Quality Management, ISO 14001 for Environmental Management and ISO 45001 for Health & Safety.

Every GA product is CE marked under EN 1090 to meet harmonised European standards for structural metalwork, so you can be 100% confident of their performance in your project.

And all our technicians and welders receive the very best training and ongoing professional development to help them make the most of the latest techniques and processes to deliver even higher levels of workmanship, quality and value.

Competitive prices

Our value engineering approach to system design delivers a solution that's purpose-built for optimum performance. The result is the right system for the right building application, produced with less waste and increased efficiency at every stage

of the process. So we're able to keep costs down without ever compromising on quality. And pass the savings on to you in our competitive prices across the board.



The Vista Group

The Vista Group is the UK's largest independent manufacturer of builders' metalwork. Created in 2018 by the merger of Vista Engineering, BPC Fixing and GA Fixings, our brands share common values of customer focus, proven products and competitive prices.

We're committed to the continuous development of our products, people and processes. Always looking for improvements in everything from our customer service levels and sustainability performance to our manufacturing processes and product design.

As a result, our products and UK facilities are certified to the very highest levels, so you can be confident you're choosing the very best for your building project.



Contents

- 4 Masonry Support
- 5 Design Considerations
- 6 VEAS Masonry Support Angle
- 8 VESS Masonry Support System
- 10 VEIB & VEIBS Individual Bracket
Masonry Support
- 12 VESB Stone Support Brackets
- 14 Fixings and Anchors

4 Masonry Support

Masonry Support

Our products and systems for masonry support can all be customised to suit the requirements of your project, ensuring the best performance and the most cost effective solution.



VEAS Masonry Support Angle



VESS Masonry Support System



VEIB & VEIBS Individual Bracket Masonry Support

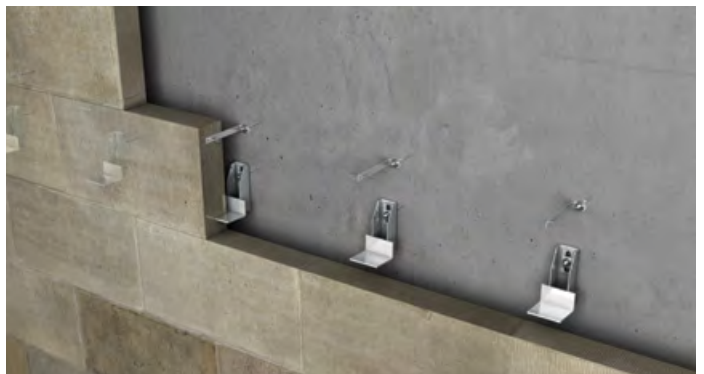

VESB Stone Support Brackets

VEAS Masonry Support Angle [Page 6](#)

Suitable for jobs with cavities less than 50mm or where the underside of the masonry panel is exposed and the cavity needs to be closed.

VEIB & VEIBS Individual Bracket Masonry Support [Page 10](#)

Individual masonry support brackets are generally used when the continuous support is difficult to achieve such as curved brickwork.

VESS Masonry Support System [Page 8](#)

Our support systems are made up of brackets welded to continuous angles at pre-designated fixing centres and are suitable for cavities in excess of 45mm.

VESB Stone Support Brackets [Page 12](#)

We follow BS8298-1,-2,-3,-4:2010 "Code of Practice for the Design and Installation of Natural Stone Cladding and Lining" as the basis for our stone support systems.

Design Considerations

Expansion Joints

Large masonry panels usually require the use of horizontal and vertical movement joints to avoid the risk of cracking or distortion of the masonry due to differential movement.

At horizontal movement joints support angles are used to support the masonry thus allowing the movement joint to expand and contract as necessary.

In general for buildings over 12m horizontal movement joints will be required at either 1 or 2 storey intervals to allow for anticipated movement of 1 mm per metre height of masonry.

For further information please consult, PD 6697:2010 Recommendations for the Design of Masonry Structures to BS EN 1996-1-1 & BS EN 1996-2

Connections

Careful consideration should be given to the method of fixing the masonry support back to the concrete or steel frame.

When fixing back to concrete frames cast-in channels used in conjunction with t-head bolts, expansion and chemical anchors are widely utilised. Cast-in channels offer the greatest adjustment and installation speed but are more expensive.

For fixing back to steel frames isolated setscrews are used to fix to UB and PFC sections, in the case of UB's additional plates are usually required between the flanges. When fixing the SHS & RHS beams blind bolts are used.

Applications / Corrosion

G.A. support systems are generally manufactured in grade 304 stainless steel which is considered suitable for most construction fixings however for more corrosive environments such as coastal or heavy industrial sites support systems can also be manufactured in grade 316. When fixing back to steel frames bi-metallic corrosion may be an issue particularly if the connection is subject to moisture. To minimise the risk of bi-metallic corrosion the dissimilar metals should be separated by use of gaskets/isolation sleeves or painted to ensure moisture is excluded from the assembled joint.

6 VEAS Masonry Support Angle

VEAS Masonry Support Angle

Use our masonry support angles where cavities are 50mm or less, or where the underside of the masonry panel is exposed and the cavity needs to be closed.



Introduction

GA Masonry Support Angles are suitable for applications where the cavity does not exceed 50mm or where the underside of the masonry panel is exposed and the cavity needs to be closed.

Support angles can be designed for walls with cavities larger than 50mm but the VESS Support System is usually a more economical option.

Service

GA undertake the design of the angle section and fixings required and will also produce layout drawings detailing the fixing positions, angle lengths and sectional details for approval prior to manufacture.

Once approved, the layout drawings are then marked up to show individual angle references for ease of location and setting out on site.

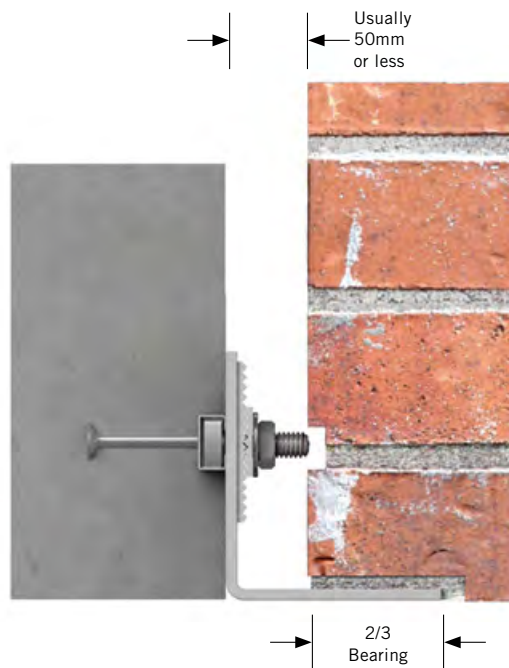

Typical Support Angle Condition

Specifying

To specify GA Support Angles follow the code as shown to the right:

In some instances an inverted angle may be required. This should be stated at the end of the code:- VEAS / 30C / 10L INVERTED.

Additional subscripts may be added to the specification to indicate factors which affect the design of the angle,
 m = masonry thickness
 p = drop below structure soffit
 INVERTED = inverted angle

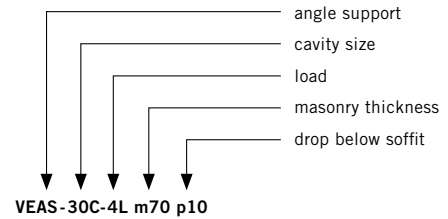
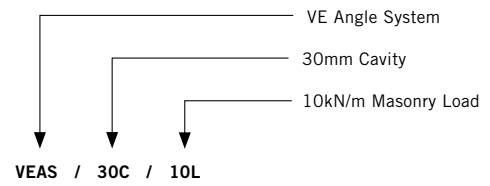

Examples of VEAS Masonry Support Angles

Example 1

Example shows a support angle fixed back to steelwork using isolated setscrews. The steelwork is drilled/slotted to suit the angle fixing centres. Serrated pads can be used to provide vertical adjustment if required.

Specify: VEAS / 40C / 3L

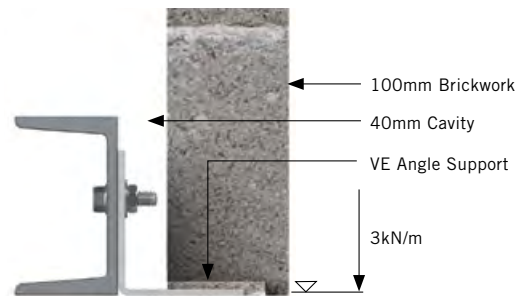

Example 2

Example shows a support angle fixed back to steelwork using Molabolts. The steelwork is drilled to suit the angle fixing centres. Serrated pads can be used to provide vertical adjustment if required.

Specify: VEAS / 20C / 5L INVERTED

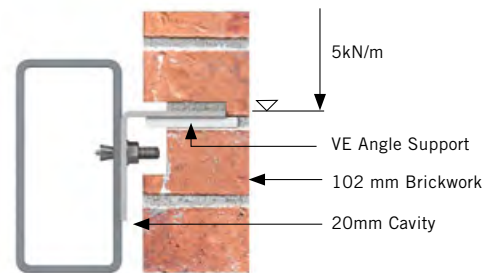

Example 3

Example shows a support angle fixed back to concrete via 38/17 cast-in channel. The 38/17 channel provides horizontal adjustment while the use of serrated pads provides vertical adjustment.

Specify: VEAS / 40C / 18L

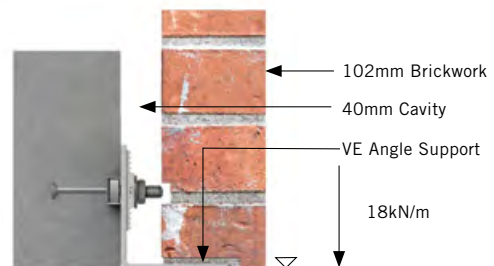

8 VESS Masonry Support System

VESS Masonry Support System

A range of brackets welded to continuous angles at pre-designated fixing centres. Suitable for cavities wider than 45mm, masonry support systems are fabricated to your specific requirements.

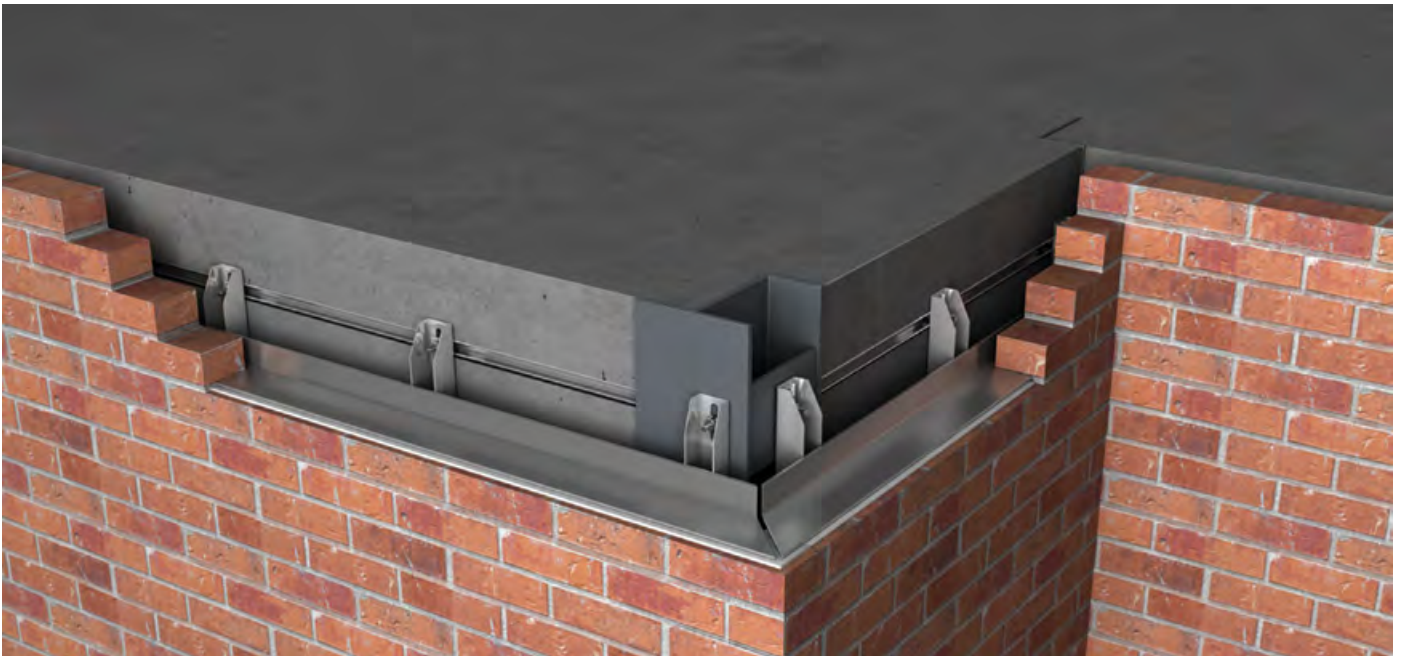

Introduction

GA Masonry Support Systems comprise of brackets welded to continuous angles at pre-designated fixing centres. They are suitable for cavities in excess of 45mm.

Support systems are 'tailor made' to suit every individual application ensuring cost effective design solutions for every masonry support requirement.

Adjustment

The brackets offer up to +/- 30mm vertical adjustment by utilising an 18 x 70 vertical slot in conjunction with a welded serrated pad. The welded serrated pad stops any potential slip.



Specifying

To specify GA Support Systems follow the code as shown below:

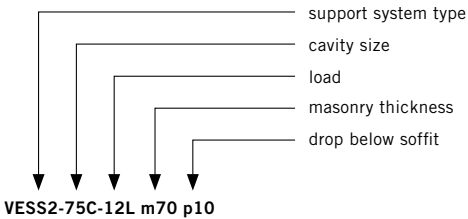
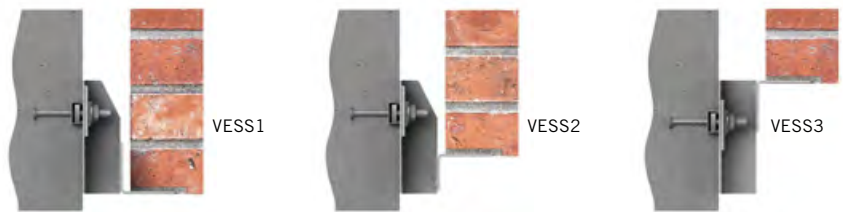
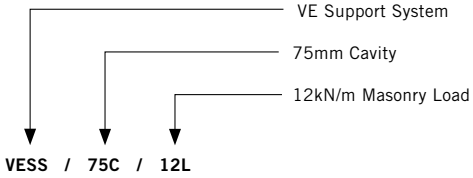

Additional subscripts may be added to the specification to indicate factors which affect the design of the system,
 m = masonry thickness (if different to 102mm)
 p = drop below structure soffit
 d = angle drop below bracket
 n = bracket notched (to suit projecting SFS)



Examples of GA VESS Masonry Support System

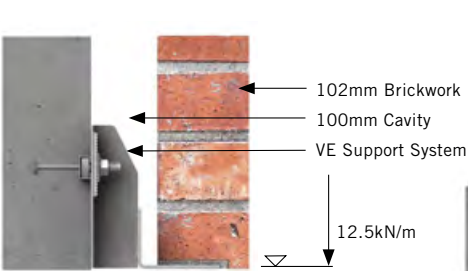

Example 1

Example shows a support system fixed back to concrete via 38/17 channel. The 38/17 channel provides horizontal adjustment while the bracket provides vertical adjustment.

Specify: VESS1 / 100C / 12.5L

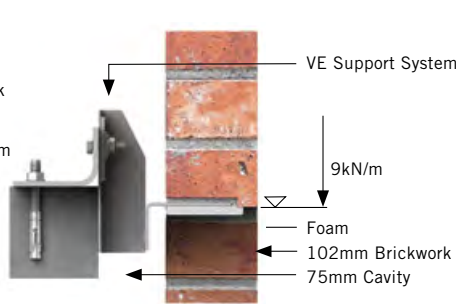

Example 2

Example shows a support system fixed back to concrete via fixing cleats anchored into the top of the slab. Slots in the fixing cleat provide horizontal adjustment while the bracket provides vertical adjustment. This method of fixing is useful for lightweight slabs and hollow core planks where fixing to the face cannot be achieved.

Specify: VESS2 / 75C / 9L

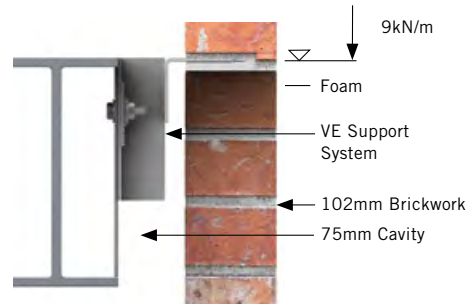

Example 3

Example shows a support system fixed back to steelwork using isolated setscrews. Plates/cleats are welded between the beam flanges and usually incorporate a punched slot for horizontal tolerance, the bracket provides vertical adjustment.

Specify: VESS3 / 75C / 9L

10 VEIB & VEIBS Individual Bracket Masonry Support

VEIB & VEIBS Individual Bracket Masonry Support

For use when continuous support is impractical, individual masonry support brackets are the ideal solution in non-standard construction methods such as curved brickwork.

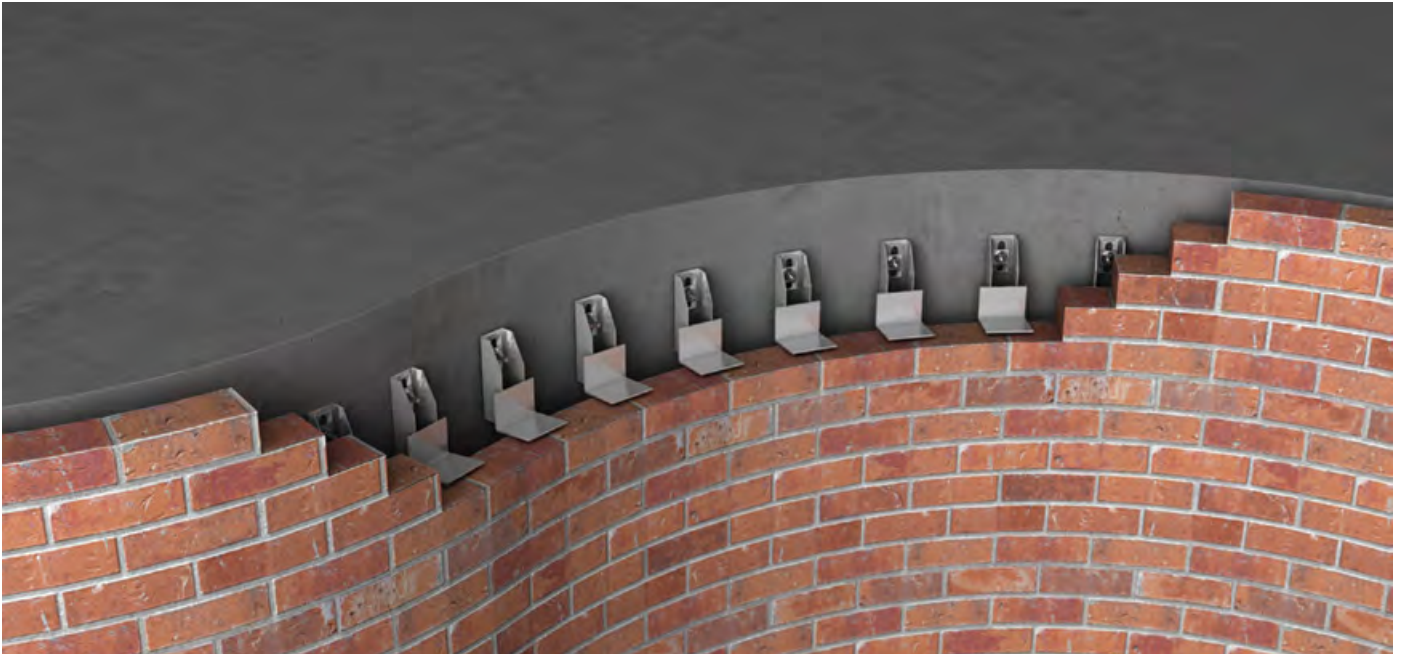

Introduction

GA Individual Masonry Support Brackets are generally used when use of continuous support is difficult to achieve such as curved brickwork or where masonry is supported from above such as soldier courses. Individual brackets are designed for each specific application ensuring the most cost effective solution for any given loading criteria.

Adjustment

The use of welded serrated pads and punched vertical slots on both the angle and system type brackets offers up to +/- 30mm vertical adjustment.

Service

GA undertake the design of the system and fixings required. GA will also produce layout drawings detailing the fixing positions, angle lengths and sectional details issued for approval prior to manufacture.

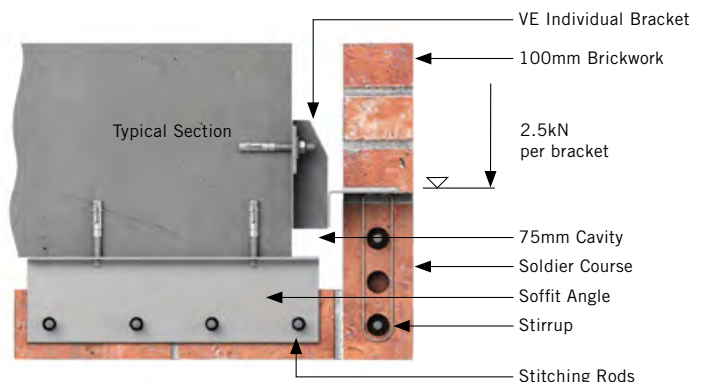
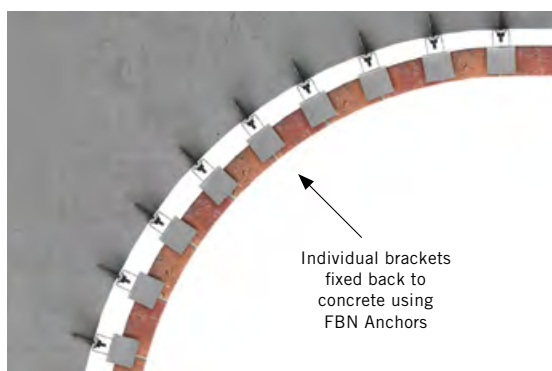

Specify: VE / IB2 / 75C / 2.5L

Specifying

To specify GA Support Brackets follow the code as shown to the right.
 Note:-The cavity will determine whether an angle or a system is used.
 Brackets can be supplied with a plain horizontal slot if required.

Additional subscripts may be added to the specification to indicate factors which affect the design of the bracket,
 m = masonry thickness (if different to 102mm)
 p = drop below structure soffit
 d = angle drop below bracket
 n = bracket notched (to suit projecting SFS)

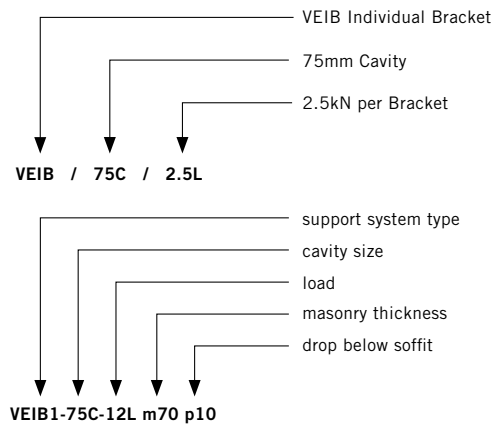

Bracket References

The bracket/angle configuration can be arranged to accommodate the structure, fixing and support levels:



VEIB1



VEIB2



VEIB3



VEIB4



VEIB5



VEIBS1



VEIBS2

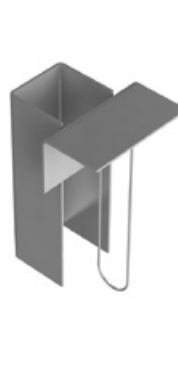

VEIBS3



VEIBS4



VEIBS5

12 VESB Stone Support Brackets

VESB Stone Support Brackets

Following BS2898:2010 standards for the design and installation of natural stone cladding and lining, GA stone support systems adhere to building industry regulations and best practice.



Introduction

Wherever possible the recommendations in BS8298-1,-2,-3,-4:2010 "Code of Practice for the Design and Installation of Natural Stone Cladding and Lining" are used as the basis for our design.

The document discusses recommendations on all aspects of natural stone support ranging from materials to fixing positions and required bearings.

In the case of cast stone units, the fixing options are increased as cast-in fixings may also be considered.

Adjustment

The use of welded serrated pads and punched vertical slots on both the angle and system type brackets offers up to +/- 30mm vertical adjustment.

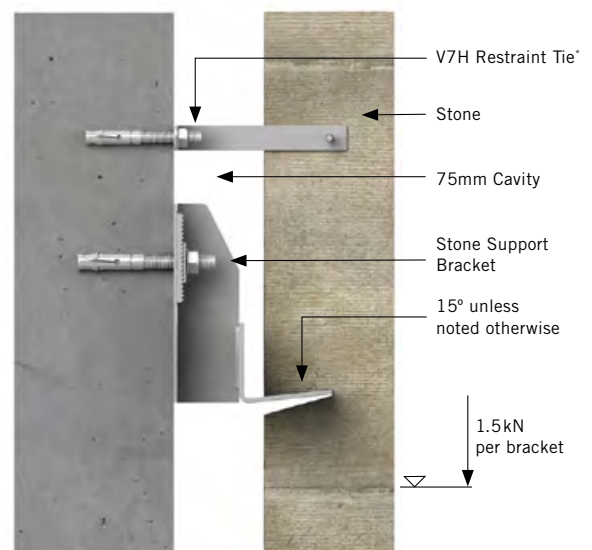

*V7H Restraint Tie available in our Wall Tie brochure

Specifying

To specify GA Stone Support Brackets follow the code as shown.
 Note:- Cavity will determine whether angle or system is used.
 Brackets can be supplied with a plain horizontal slot if required.

Additional subscripts may be added to the specification to indicate factors which affect the design of the bracket,

s = stone thickness

p = drop below structure soffit

d = angle drop below bracket

n = bracket notched (to suit projecting SFS)

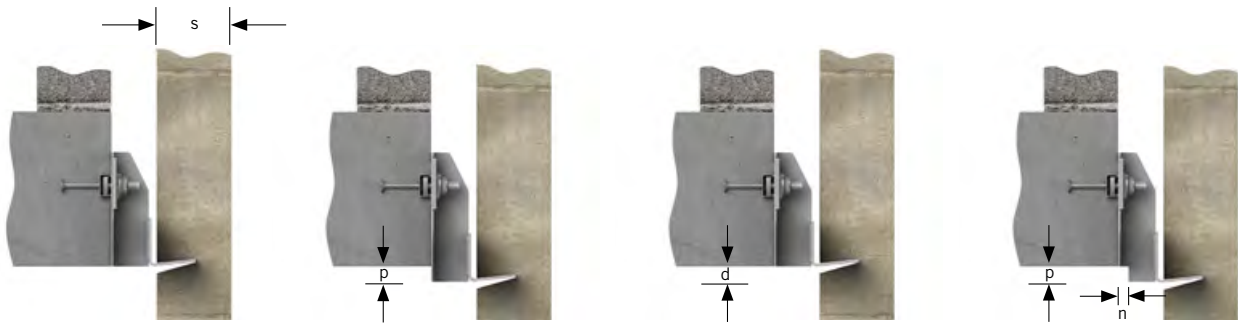
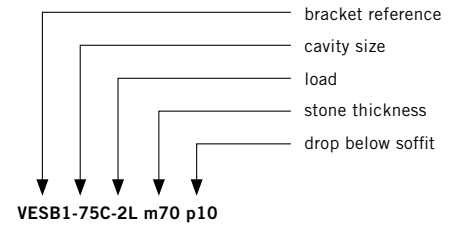
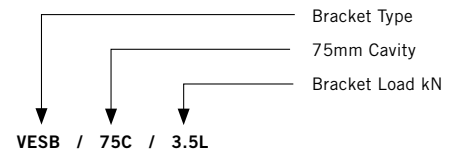

Bracket References

The bracket/angle configuration can be arranged to accommodate the structure, fixing and support levels:

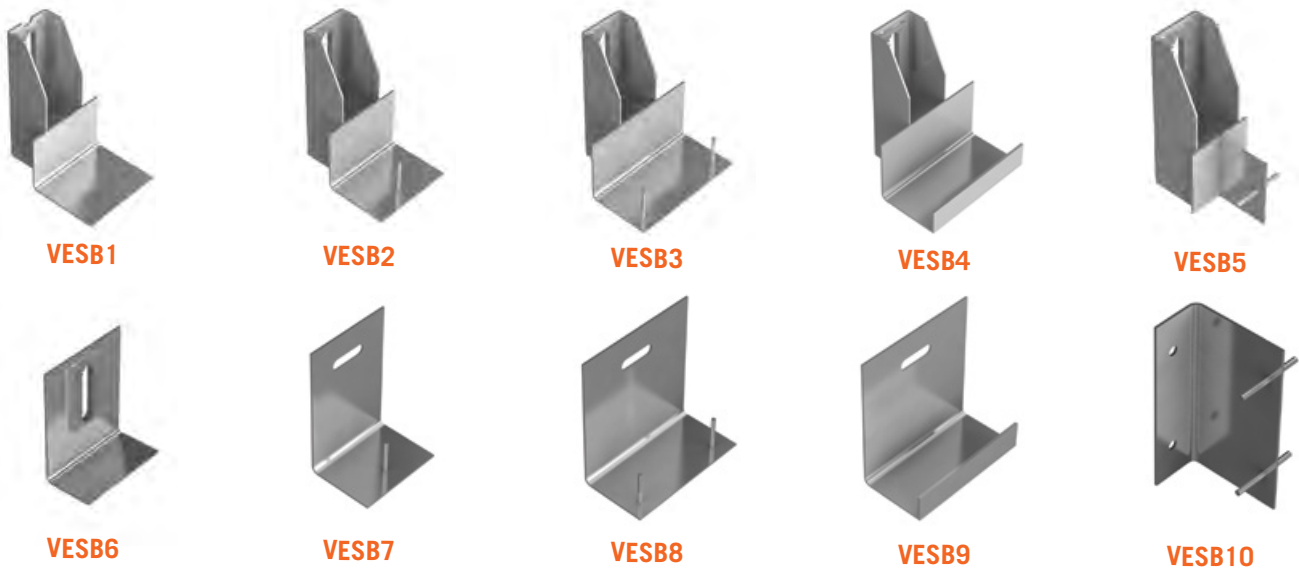

Example 1

Example shows stone support bracket fixed back to concrete using an M.D. Anchor. The use of a VESB1 type bracket with overbent angle ensures that the base of the stone unit is both supported and restrained with additional ties only required at the head of the unit.

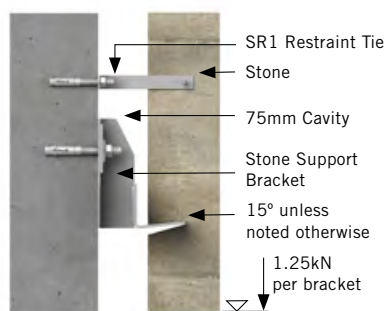

Specify: VE / SB1 / 75C / 1.5L

Example 2

Example shows VESB5 support bracket fixed back to concrete using an M12 M.D. Anchor. The stone unit is both supported and restrained by the dowel with additional ties only required at the head of the unit. The soffit stone is suspended using GA C1 restraint ties fixed back to concrete via 28/15 cast-in channel.

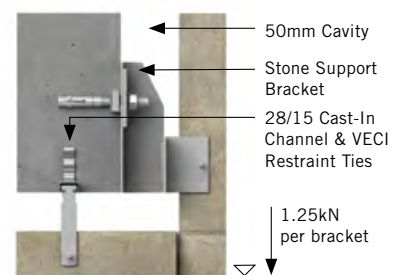

Specify: VE / SB5 / 50C / 1.25L

14 Fixings and Anchors

Fixings and Anchors

Because masonry support systems can only be as strong as the fixings that hold them in place, we only specify high quality anchors from leading suppliers.

GA offer a wide variety of fixings and anchors to deliver optimum performance and security in all applications. Our engineers will help you choose the most appropriate solution for the materials and load bearing requirements of your project.

FBN II Anchors

FBN II Anchors are used for fixing back to concrete, they are quick to install and offer good load performance in both shear and tension.

FBN II Anchors are available in zinc plated and stainless steel versions.



Chemical Anchors

Anchor Studs

Chemical anchor studs are used with both the chemical capsule and chemical injection type fixing. The studs are available in zinc plated, galvanised and grade A2 stainless steel. (A4 available on request).



C.C. Anchors - Fisher Type R

Chemical capsules consist of a resin mixture and a small internal tube of hardener which when mixed cure to give a high load anchorage point.



C.I. Anchors - FIS VL 410 C / FIS V360

Chemical injection mortars are used where close edge and centre distances are required together with high load performance.



Setscrews

Setscrews are available in mild steel, galvanised and stainless steel in a wide range of diameters, lengths and material grades.

Stainless steel setscrews can be supplied shrinkwrapped and are supplied with nylon washers to prevent bi-metallic corrosion when fixing to mild steel.



Molabolt

The Molabolt is fast, easy to use and requires no specialist tools to create a completely secure hold.

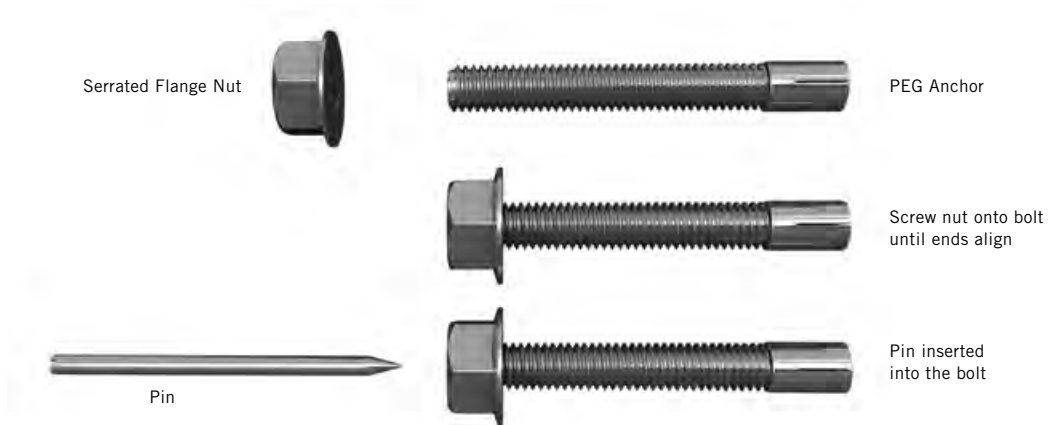

Bolt assembly placed in hole



Strike pin home



Tighten bolt to recommended torque

Cast-In Channels and T-Head Bolts

The GA Cast-In Channel has a toothed edge to its return lips, matched by a serrated surface on the underside of the T-Head bolt. This arrangement creates a high resistance to slip and shear loads along the line of the channel.



Available from:

All illustrations, technical information, descriptions, British and European Standards contained within this publication are intended for guidance only and shall not constitute a "sale by description". All information is provided correct at time of printing (MARCH 2023). The Company pursues a policy of constant product development and information contained in this publication is therefore subject to change without notice. All dimensions given are nominal. Updates will not be issued automatically. The information is not intended to have any legal effect, whether by way of advice, representation or warranty (express or implied). We accept no liability whatsoever (to the extent permitted by law) if you place any reliance on this Publication you must do so at your own risk.

Please contact GA Fixings should you have any technical enquiries.

©GA Fixings 2023.

Part of the Vista Group

- Vista Engineering Ltd - Glasgow
- BPC Building Products Ltd - Wakefield
- ☆ GA Fixings Ltd - Barnsley
- △ Vista Engineering Ltd - High Peak
- Locusrite Ltd - Maldon



GA Fixings Ltd

Unit K, Zenith Park
Whaley Road, Barugh Green
Barnsley, S75 1HT

Tel: 01226 380779

Fax: 01226 385558

www.gafixings.com

info@gafixings.com

Head Office

Vista Group, Carr Brook Works
Elnor Lane, Whaley Bridge
High Peak, SK23 7JN

01663 736700

www.vistaeng.co.uk

sales@vistaeng.co.uk

Contact us to enquire about our other product ranges.

GA
A Vista Group Company